

Please carefully read and follow all instructions, guidelines and warnings included in this product manual in order to ensure that you install, use and maintain the product properly at all times.

By using the product, you hereby confirm that you have read this disclaimer, all instructions, guidelines and warnings carefully and that you understand and agree to abide by the terms and conditions as set forth herein.

You agree to use this product only for the intended purpose and application and in accordance with the instructions, guidelines and warnings as set forth in this product manual as well as in accordance with all applicable laws and regulations.





A failure to read and follow the instructions and warnings set forth herein may result in an injury to yourself and others, damage to your product or damage to other property in the vicinity.

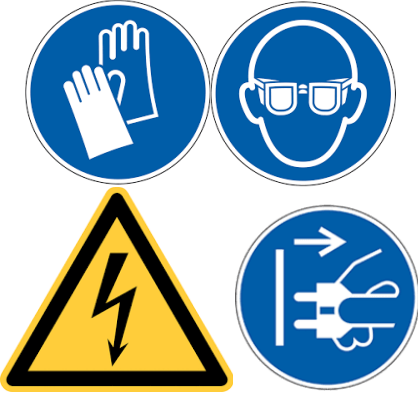
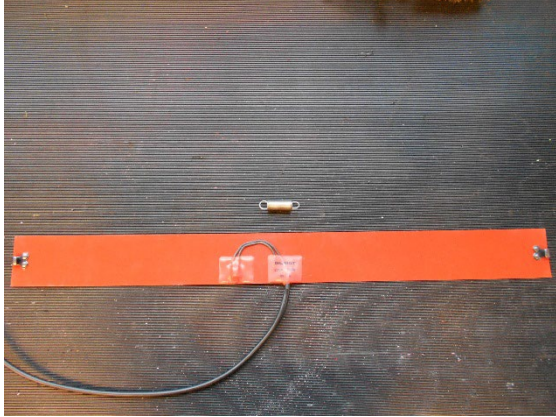
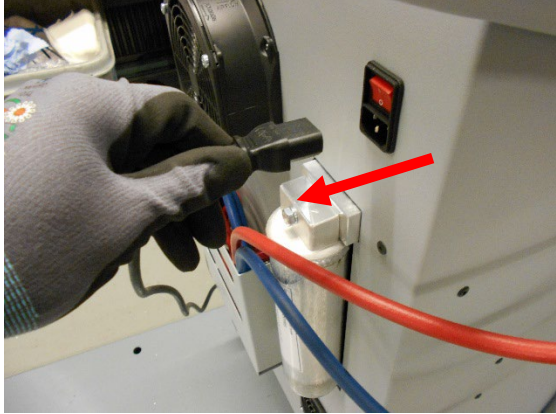

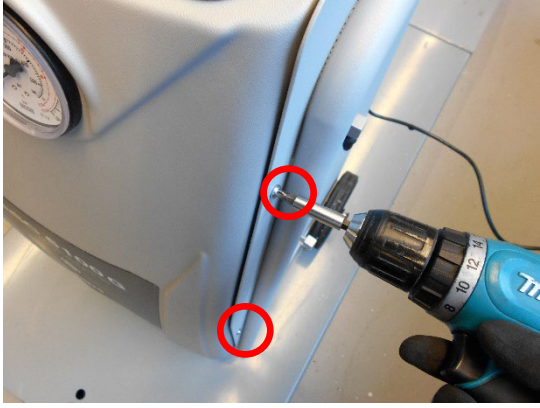
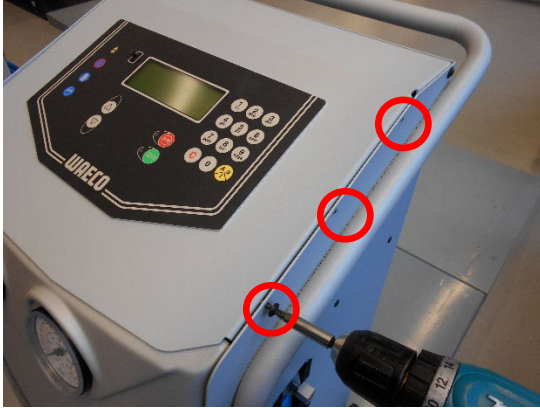
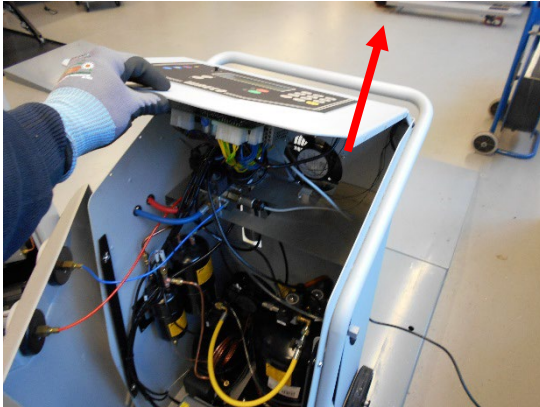
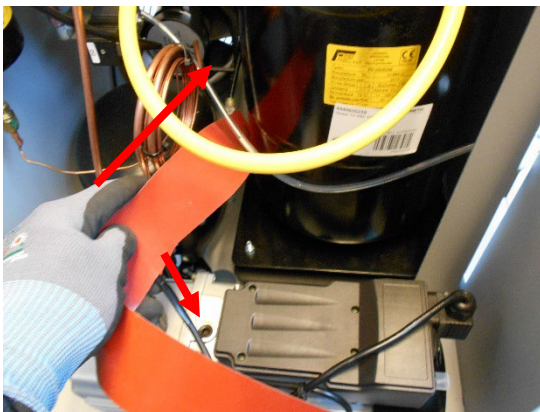
Dometic accepts no liability for any loss, damage or injury incurred, directly or indirectly, from the installation, use or maintenance of the product not in compliance with the instructions and warnings in the product manual.

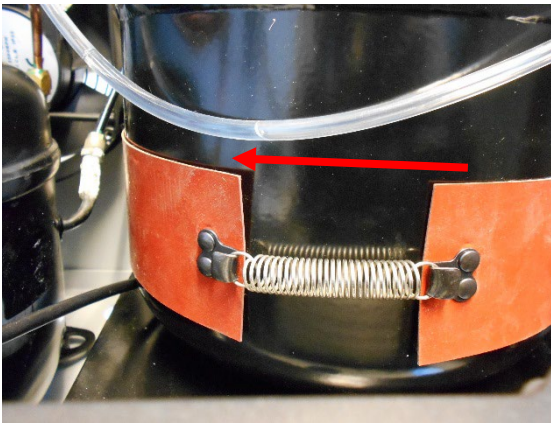

This product manual, including the instructions, guidelines and warnings, and related documentation may be subject to changes and updates. For up-to-date product information, please visit: [documents.dometic.com](http://documents.dometic.com), [dometic.com](http://dometic.com).

#	Picture	Description
1		<p><b>These subsequent work may only be carried out by qualified persons!!!</b></p> <p>Before starting work, the first thing you should do is pull out the mains plug and secure the device against being switched back on!!!</p> <p>Only work with gloves and goggles!!!</p>
2		<p>Remove the heat belt and the tension spring from the packaging.</p>
3		<p><b>Check again if the power plug is pulled!!!</b></p>

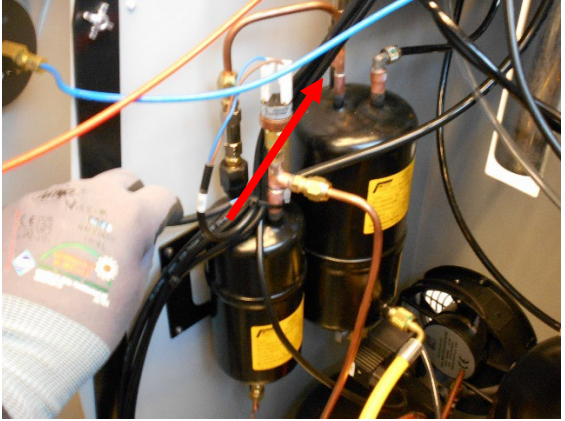
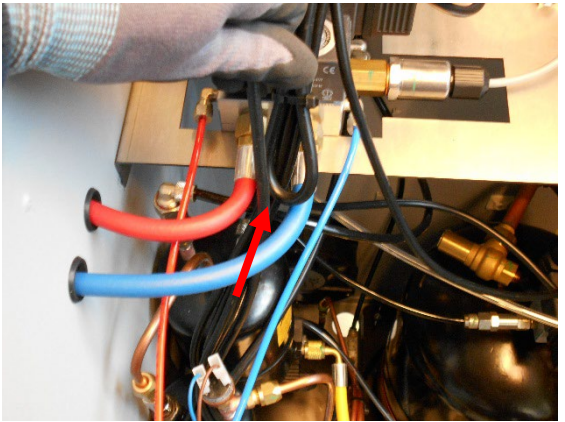
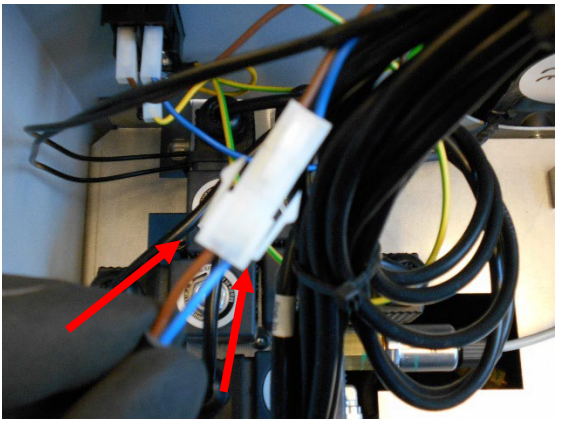
#	Picture	Description
4		<p>Remove both screws from the front cover.</p>
5		<p>Remove 3 front screws each side but not the last one because of turn up the logic board.</p>
6		<p>Turn up the logic board.</p>
7		<p>The heat belt has to be layed around the internal tank. The cable has to be showed to the bottom.</p>

#	Picture	Description
8		<p>Fix the heat belt with the help of the tension spring.</p>
9		<p>The heat belt has to be placed 50mm above the bottom plate.</p>
10		<p>The distance between heat belt and oil hose has to be checked. 20mm is needed.</p>
11		<p>The cable of heat belt has to be layed from the bottom to the top and fixed by a cable stripe.</p>

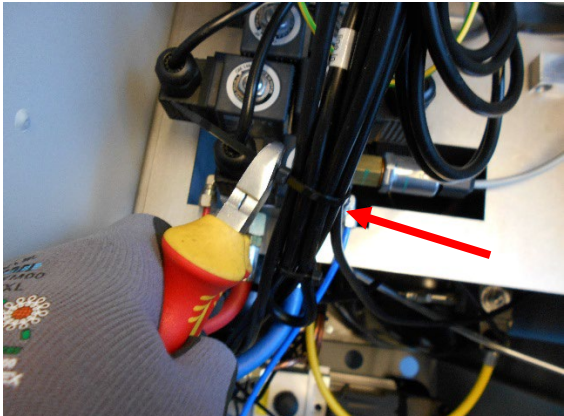
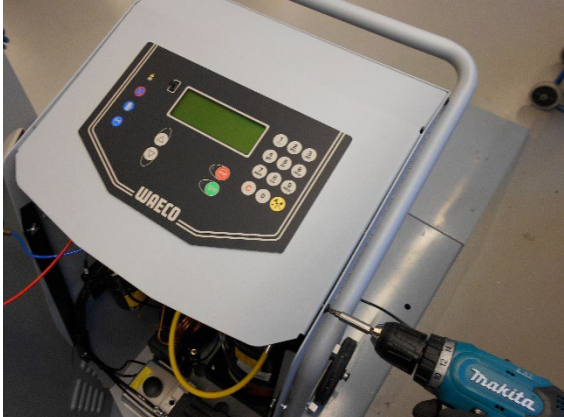
#	Picture	Description
12		<p>Next step is to put the cable between both connections of the oil separator.</p>
13		<p>The cable has to be layed between both service hoses.</p>
14		<p>Fix the blue and the brown cable inside the white cable connection.</p>
15		<p>Fix the cable with a cable stripe.</p>

#	Picture	Description
16		<p>The rest of the cable stripe has to be cut.</p>
17		<p>Flap down the logic board and fix the screw with one screw only.</p>
18		<p><b>Before switching on the unit, check the unit with a Secu Test device against DIN VDE 0701-0702</b></p> <p>Switch on the unit and use the service code 1212 to check the heat belt by pressing the key 5.</p>
19		<p>Use a special thermometer to check the increase temperature.</p> <p><b>Do not touch the unit internal by hand!!!</b></p>

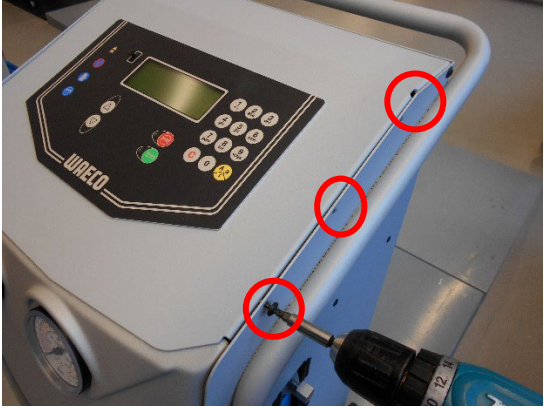
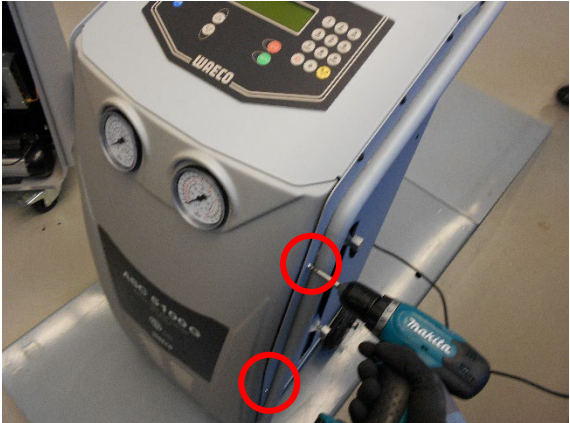
#	Picture	Description
20		<p><b>At least screw on the logic board.</b></p>
21		<p><b>Fix the front cover.</b></p>

Lesen und befolgen Sie bitte alle Anweisungen, Richtlinien und Warnhinweise in diesem Produkthandbuch sorgfältig, um sicherzustellen, dass Sie das Produkt jederzeit ordnungsgemäß installieren, verwenden und warten.



Durch die Verwendung des Produktes bestätigen Sie hiermit, dass Sie diesen Haftungsausschluss, alle Anweisungen, Richtlinien und Warnhinweise sorgfältig gelesen haben und dass Sie die hierin dargelegten Bestimmungen verstanden haben und ihnen zustimmen. Sie erklären sich damit einverstanden, dieses Produkt nur für den angegebenen Verwendungszweck und in Übereinstimmung mit den Anweisungen, Richtlinien und Warnhinweisen dieses Produkthandbuchs sowie in Übereinstimmung mit allen geltenden Gesetzen und Vorschriften zu verwenden.

Eine Nichtbeachtung der hierin enthaltenen Anweisungen und Warnhinweise kann zu einer Verletzung Ihrer selbst und anderer Personen, zu Schaden an Ihrem Produkt oder zu Schaden an anderem Eigentum in der Umgebung führen.



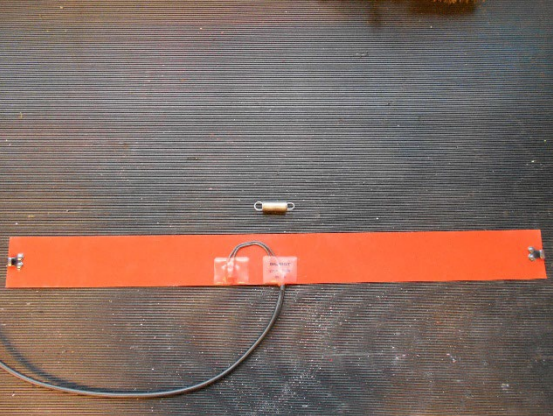
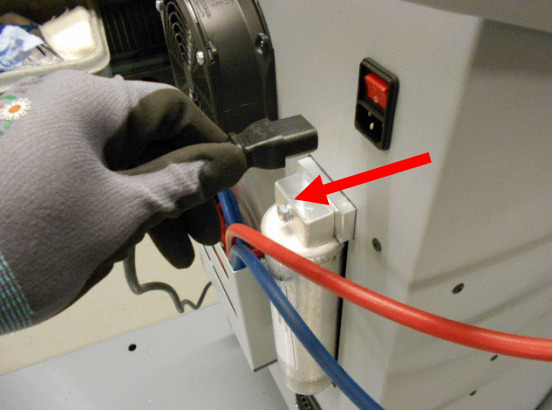

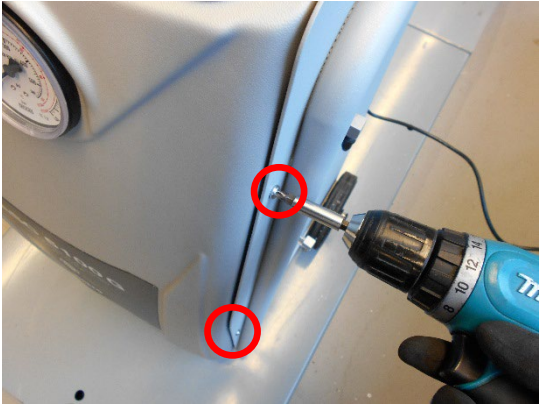
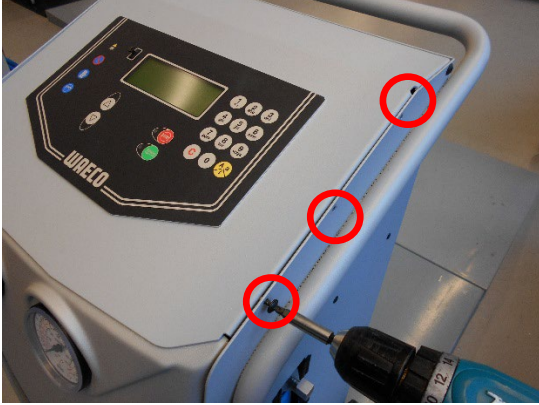
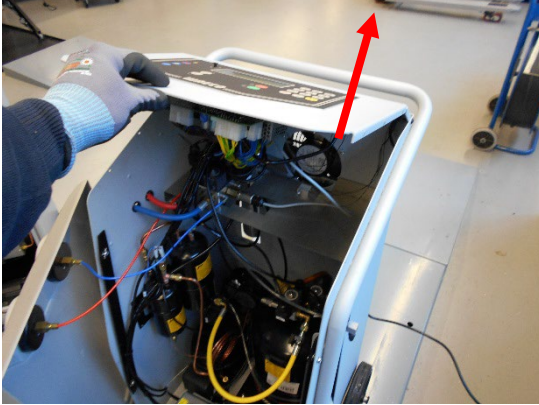
Dometic übernimmt keine Haftung für Verluste, Schaden oder Verletzungen, die direkt oder indirekt durch die Installation, Verwendung oder Wartung des Produktes entstehen, wenn die Anweisungen und Warnhinweise in diesem Produkthandbuch nicht befolgt werden.



Dieses Produkthandbuch, einschließlich der Anweisungen, Richtlinien und Warnhinweise, sowie die zugehörige Dokumentation können Änderungen und Aktualisierungen unterliegen. Aktuelle Produktinformationen finden Sie unter [documents.dometic.com](http://documents.dometic.com), [dometic.com](http://dometic.com).



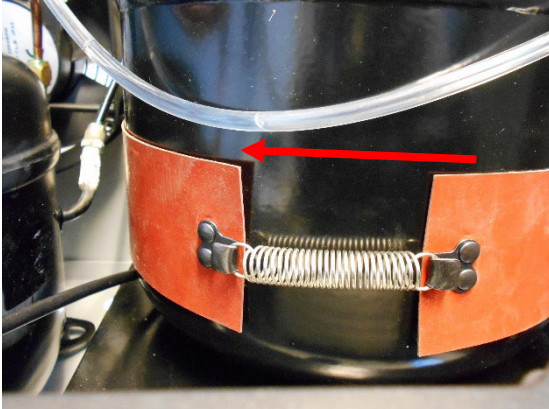

#	Abbildung	Beschreibung
1		<p><b><i>Diese hier nachfolgenden Arbeiten dürfen nur von Fachpersonal durchgeführt werden!!!</i></b></p> <p><b>Bevor mit der Arbeit begonnen wird sollte als aller erstes der Netzstecker gezogen werden und das Gerät gegen wiedereinschalten gesichert werden!!!</b></p> <p><b>Nur mit Handschuhen und Schutzbrille arbeiten!!!</b></p>
2		<p><b>Heizband und Zugfeder aus der Verpackung nehmen.</b></p>
3		<p><b><i>Nochmals überprüfen ob der Netzstecker gezogen wurde!!!</i></b></p>

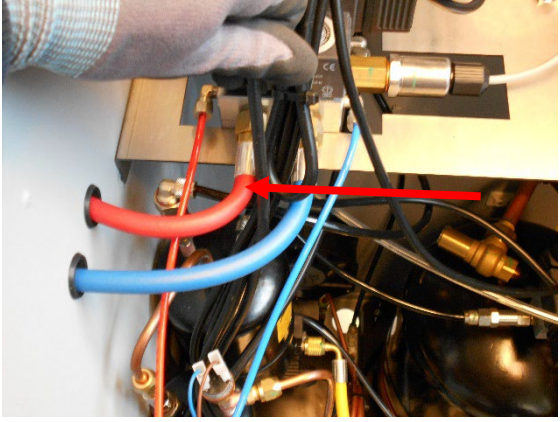
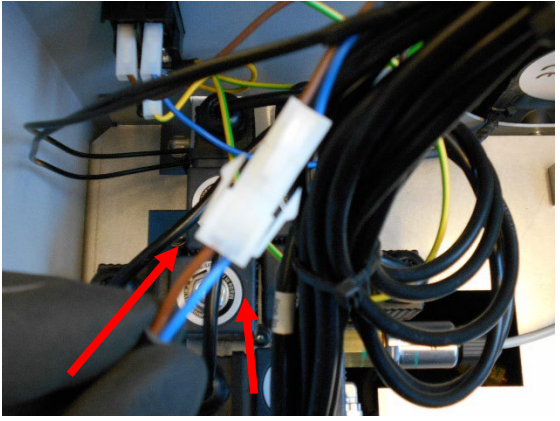
#	Abbildung	Beschreibung
4		<p>Die 2 Kreuzschrauben pro Seite des Frontcovers entfernen.</p>
5		<p>Nun die vorderen, je 3 Schrauben pro Seite des Bedienfeldes entfernen. Die beiden hinteren Schrauben werden zum aufklappen des Bedienfeldes benötigt.</p>
6		<p>Bedienfeld hochklappen.</p>
7		<p>Das Heizband nehmen und so um den Tank legen sodass das Kabel nach unten zeigt.</p>

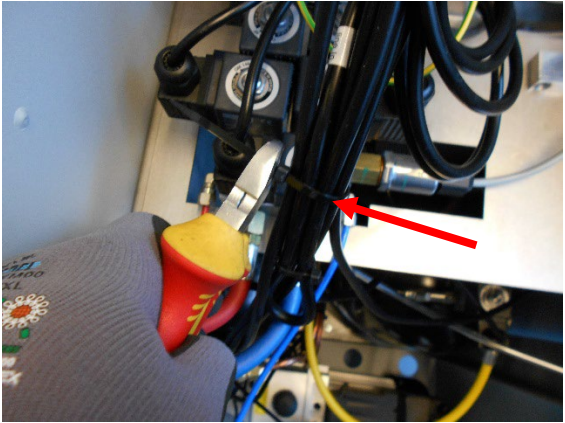

#	Abbildung	Beschreibung
8		<p>Das Heizband mit der mitgelieferten Zugfeder befestigen.</p>
9		<p>Das Heizband muss so um den Tank gelegt werden das die Unterkante 50mm vom Bodenblech entfernt ist.</p>
10		<p>Unbedingt darauf achten das genügend Abstand zum Ölschlauch vorhanden ist. Ca. 20mm sind empfehlenswert.</p>
11		<p>Das Kabel des Heizbandes mit Kabelbinder (nicht im Lieferumfang) am Hauptkabelbaum befestigen und von unten nach oben verlegen.</p>

#	Abbildung	Beschreibung
12		<p>Dann das Kabel zwischen den beiden Leitungen des Ölabscheiders durchführen.</p>
13		<p>Anschließend das Kabel zwischen beiden Serviceschläuchen durchführen.</p>
14		<p>Beide Kabelenden in den Stecker führen und an richtiger Position einrasten lassen.</p>
15		<p>Kabelverlegung zusätzlich mit Kabelbindern befestigen.</p>

#	Abbildung	Beschreibung
16		<p>Alle Kabelbinder abkneifen.</p>
17		<p>Bedienfeld herunterklappen und vorerst nur mit einer Schraube befestigen.</p>
18		<p><b>Vor dem ersten Start bitte einen Secu Test machen nach DIN VDE 0701-0702 durchführen!!!</b></p> <p>Gerät starten und in das Service-Menü 1212 mit der Taste 5 das Heizband ansteuern.</p>
19		<p>Mit einem Thermometer (Optimalerweise ein Infrarotthermometer) die stetig ansteigende Temperatur überprüfen.</p> <p><b>Nicht mit der Hand ins Gerät fassen!!!</b></p>

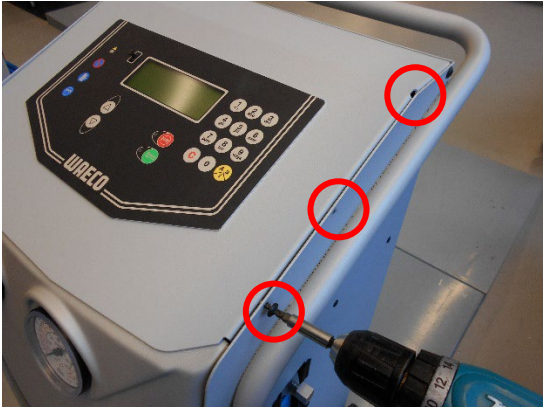
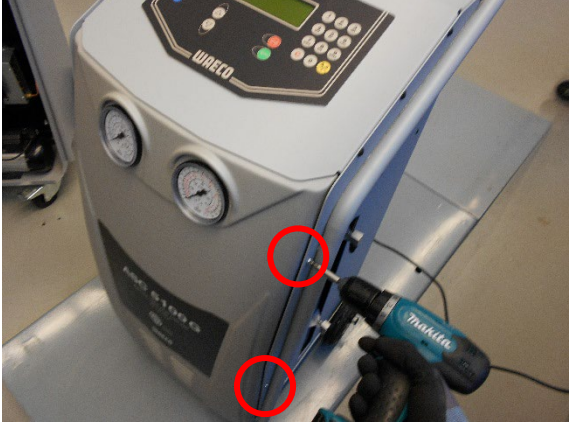
#	Abbildung	Beschreibung
20		<p><b>Abschließend wieder das Bedienfeld befestigen.</b></p>
21		<p><b>Frontcover wieder befestigen.</b></p>

This page is intentionally left blank.

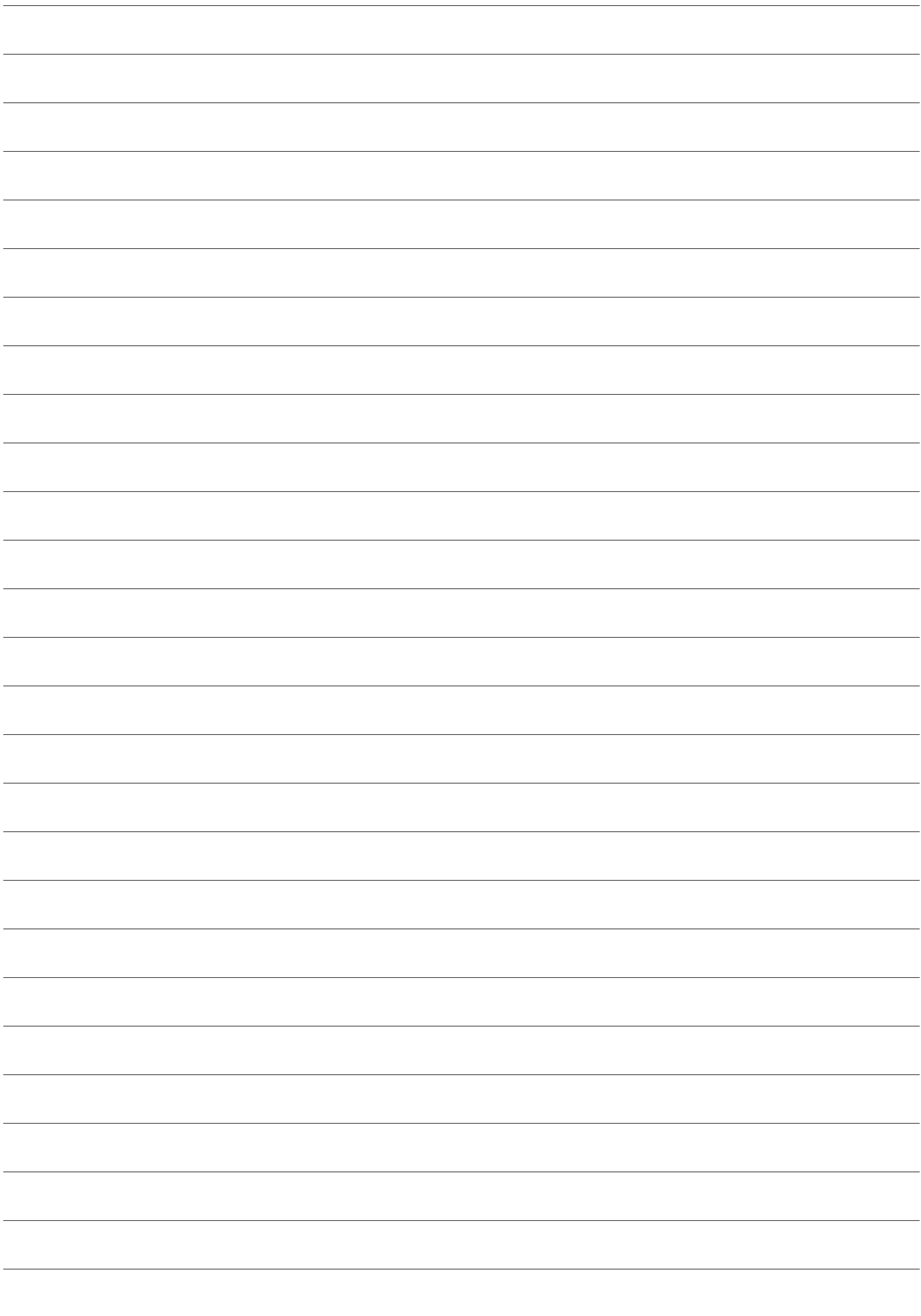

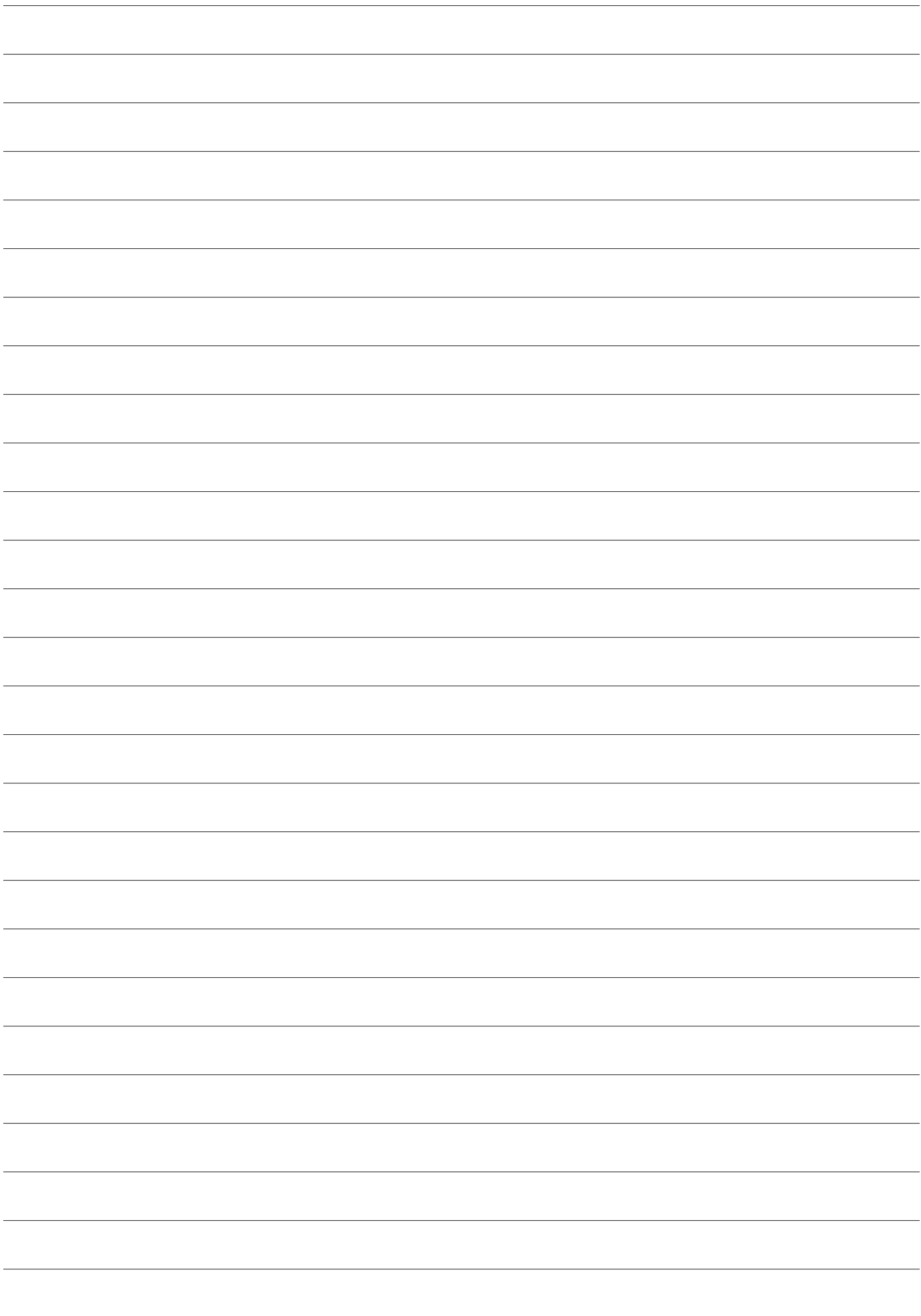

**waeco.com**

---

## **SUPPORT**

**[waeco.com/en/de/support](https://waeco.com/en/de/support)**

## **SALES**

**[waeco.com/en/de/contact](https://waeco.com/en/de/contact)**

---